

CURRENT RATE [A]	VERSIONS AND PART NUMBERS
30	0283030.MXJ
40	0283040.MXJ
50	0283050.MXJ
60	0283060.MXJ
70	0283070.MXJ
80	0283080.MXJ
100	0283100.MXJ
120	0283120.MXJ
140	0283140.MXJ

LTR	DATE	REVISION	DRW
A	11/FEB/23	526175GCA - INITIAL RELEASE	OPL

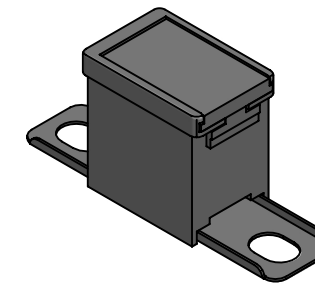

ISOMETRIC VIEW

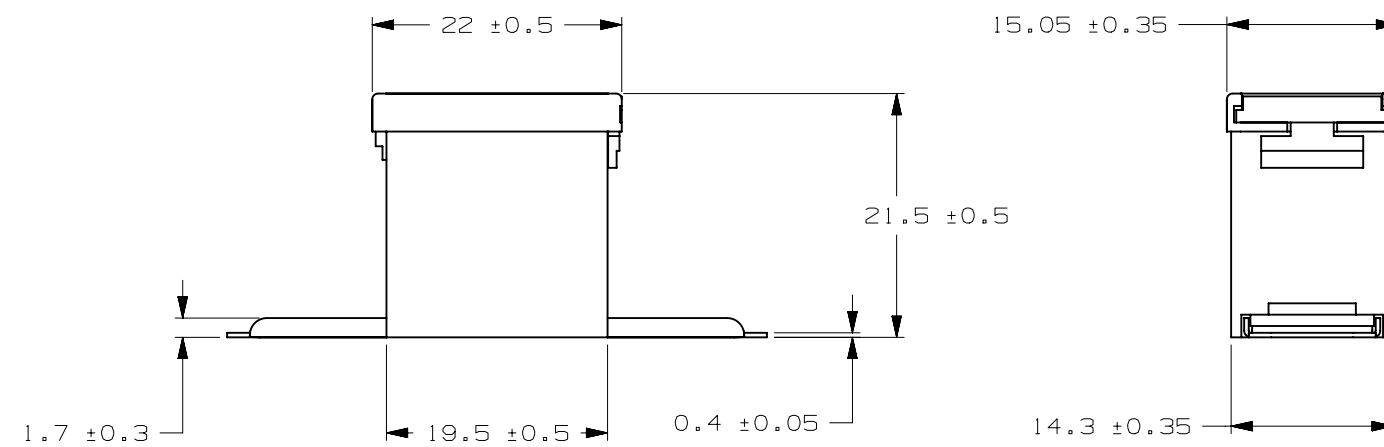
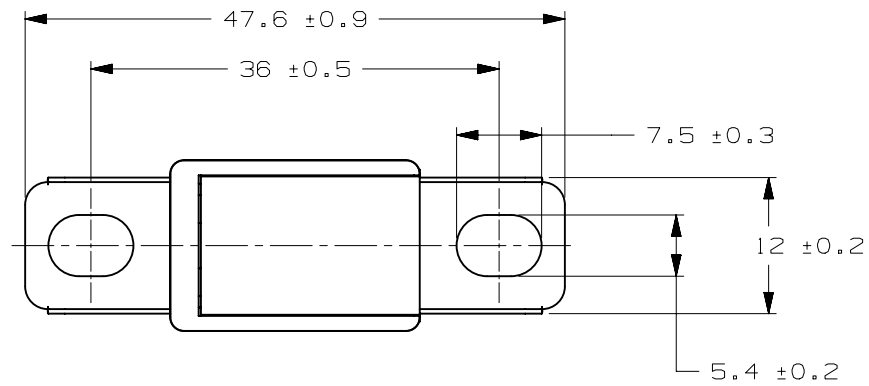

PAL FUSE 283 32V	
TERMINAL MATERIAL:	COPPER ALLOY
TERMINAL PLATING:	NONE
HOUSING MATERIAL:	30A-70A: PA66 GF33 80A-140A: PET GF 30
COVER MATERIAL:	30A-60A: PC/TRANSPARENT 80A-140A: PES/TRANSPARENT

DIM	LINEAR DIMENSIONS				ANGLES	RADI
	.5 - 6	6 - 30	30 - 120	120 - 400		
TOL	±0.1	±0.2	±0.3	±0.5	±0.5°	±0.2

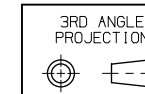

REVISION
A

DRWG. NO.
WEB-0283000.MXJ